

Splendide
Laundry Centers

2100XC

Automatic Clothes Washer-Dryer
Instructions for use

WD2100XC
WD2100XCP

Read All Instructions Before Using

Contents

General information, 1-2-3-4-5

Technical Information, 2-3

For your safety, 4

Introduction, 5

Installation requirements, 6-7

Attention / Grounding instructions, 6

Electrical, location and draining, 7

Installing the washer-dryer, 8-9-10-11

Unpacking the washer-dryer, 8

Removing the transit screws, 8

Connecting the water inlets, 9

Connecting the drain hose, 9

Installing the exhaust ducting, 10

Leveling the washer-dryer, 10

Completing the installation, 11

About your appliance, 12-13-14-15

Washer-dryer special features, 12

Control panel, 13

Option buttons, 14

Program key, 14

Detergent and laundry aids, 15

Dispenser drawer, 15

Washing and drying, 16-17-18-19

Cycle Description Chart, 16

Before starting a cycle, 17

Determining load sizes, 17

Setting a 'wash', 'dry' or 'wash-to-dry' cycle, 17

Splendide laundry tips, 18

For best results, 18

Combo laundry FAQ's / Sample loads, 19

Care and maintenance, 20-21

Turning off the water or electricity supply, 20

Cleaning the dispenser drawer, 20

Checking the water inlet hoses, 20

Cleaning the pump pre-chamber, 21

Checking the dryer vent, 21

No lint filter to clean, 21

Troubleshooting, 22-23

Troubleshooting Chart, 22



If you need assistance, 23

General Information

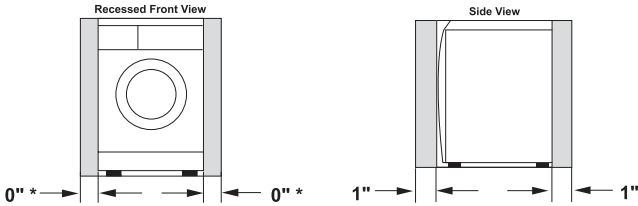

This appliance was tested by UL and conforms with both Canadian and U.S. UL safety requirements and displays their mark.

Technical information

Model WD2100XC(P)	Splendide 2100XC, Splendide 2100XCP
Weight	148 lbs.
Dimensions	Width: 23.4" (59.5 cm) Height: 33.25"-33.75" (84.5-85.7 cm) Depth: 22" (55.9 cm)
Minimum Installation Clearances	Sides: 0" Front / Back: 1"
Capacity	Washing: 2 to 15 lbs. (1 to 7 kg) Drying: 2 to 11 lbs. (1 to 5 kg)
Electrical Connection	Voltage: 120 Volts, 10.5 Amp, 60 Hz Max. Absorbed Power: 1300 Watts
Water Connection	Max. Pressure: .69 MPa (6.9 bar), 100 PSI Min. Pressure: 0.05 MPa (0.5 bar), 7.5 PSI
Max. Spin Speed	Up to 1200 RPM
Min. Installation Spacing	 <p>This appliance may be installed in a recessed area, closet or alcove. The installation spacing is in inches and is the minimum acceptable. *Additional spacing should be considered for easy installation, servicing and compliance with local codes and ordinances. Installations must conform with the minimum dimensions indicated.</p>
Dryer Exhaust Requirements	<p>WARNING! To reduce the risk of fire, this appliance must be exhausted to the outdoors.</p> 

NOTE: The manufacturer reserves the right to make any improvements to its appliances without giving prior notice.

For Your Safety

Save These Instructions

Your washer-dryer has been built in compliance with the strictest international safety regulations. However, for your safety, the information in this manual must be followed to minimize the risk of fire or explosion, electric shock, or to prevent property damage, personal injury, or loss of life.

Read all instructions before using any appliance.

- Do not wash or dry articles that have been previously cleaned in, washed in, or spotted in gasoline, dry cleaning solvents, other flammable/explosive substances as they emit vapors that could ignite or explode.
- Before the appliance is removed from service or discarded, remove the door to the washing/drying compartment.
- Do not repair or replace any part of the appliance or attempt any servicing unless specifically recommended in the user-maintenance instructions or in published user-repair instructions that you understand and have the skills to perform.
- Do not allow children to play on or in the appliance.
- Do not add gasoline, dry cleaning solvents, items contaminated with cooking oil or other flammable or explosive substances to the wash water. Do not install or store this appliance where it will be exposed to weather or in an area where gasoline or other flammables are stored.
- Under certain conditions, Hydrogen gas may be produced in a hot water system that has not been used for 2 weeks or more. HYDROGEN GAS IS EXPLOSIVE. If the hot water system has not been used for such a period, before using the appliance, turn on all hot water faucets and let the water flow from each for several minutes. This will release any accumulated hydrogen.
- Do not use heat to dry articles containing foam rubber or similar textured rubber-like materials.
- Turn off water faucets to relieve pressure on hoses and valves and to minimize leakage if a break or rupture occurs.
- Do not reach into the appliance if the drum is moving.
- Do not tamper with controls.
- Repair or replacement of a part should be made only by a qualified service technician to prevent personal injury or damage to the machine. Contact Splendide to locate an authorized repair service company near you.
- Disconnect power to the washer at the circuit breaker or fuse box, or unplug the machine in an emergency or when servicing is required. Have the installer show you and label the proper switch or fuse at the electrical disconnect box.
- Good, safe practices and caution MUST be applied when installing, operating, and maintaining any appliance. Follow basic precaution.
- Before loading the washer, make sure the drum is empty.

Congratulations

Introduction

Congratulations on your purchase of a Splendide. Your Splendide washer-dryer takes the drudgery out of doing laundry - simply toss dirty laundry in and get clean, dry laundry out!

Whether it's installed in a luxury RV, yacht, or apartment closet, your new Splendide is designed to fit where others won't and deliver outstanding washing and drying performance (all while conserving more energy and water than other brands). Enjoy your new Splendide!

Read this manual

Please read this manual carefully. If you need further assistance, please contact Splendide Laundry Centers (Mon-Fri 7am-5pm PST)

1-800-356-0766

For your records

Write model and serial numbers here. You can find them on the front of the machine and inside of the door opening.

Model: (i.e. WD2100XP)

Serial No:

S/N

Installation Requirements

ATTENTION!

For your own protection and to prevent accidents, injury, and fire, please read the following carefully before installing the washer-dryer.

- Installation and grounding must be done in accordance with local codes and by a qualified installer. Installation Instructions provided in this booklet are for the installers' reference.
- Washer-dryer **MUST** be installed on a strong, level floor and in a protected dry and well-ventilated area close to a power supply and drain outlet of sufficient capacity. **DO NOT** install on carpet.



IMPORTANT: Installation on carpet floors will cause the machine to vibrate and may result in excessive machine vibration during the spin cycles and loss of performance.

- The washer-dryer should be plugged into a properly grounded (3) prong electrical outlet capable of 120 Volt, 60 Hz, 1300 W, and 10.5 Amp. It shouldn't be controlled by a wall switch or pull cord which could be turned off accidentally. For your safety, the third or round grounding prong must never be removed. **DO NOT USE AN EXTENSION CORD.**
- **DO NOT** install or store this appliance where it will be exposed to weather or in an area where gasoline or other flammables are stored.

GROUNDING INSTRUCTIONS

This appliance must be grounded. In the event of malfunction, or breakdown, grounding will reduce the risk of electric shock by providing a path of least resistance for electric current. This appliance is equipped with a cord having an equipment grounding conductor and grounding plug. The plug must be plugged into an appropriate outlet that is properly installed and grounded in accordance with all local codes and ordinances. **DO NOT** modify the plug provided with the appliance. If it will not fit the outlet, have a proper outlet installed by a qualified electrician.



WARNING! Improper connection of the equipment-grounding conductor can result in a risk of electric shock. Check with a qualified electrician or serviceman if you are in doubt as to whether the appliance is properly grounded.

WARNING



ELECTRICAL SHOCK HAZARD

Disconnect power before servicing.

Replace all panels before operating.

Failure to do so can result in death or electrical shock.

Electrical

- Machine Voltage/Amperage - 120V, 60 Hz, 1300 W, 10.5 Amp.
- Connection - 3-prong plug with 6' cord is provided with the machine.
- Circuit/Protector - 3-wire single phase, 120V, 60 Hz, AC, on a separate 15 Amp circuit.

Location

- This machine may be installed free standing as well as in a recessed area, closet, or alcove
- **Minimum Installation Spacing** - 0" on sides and 1" in front and back. NOTE: Additional installation spacing needs to be considered for easy installation, servicing, and compliance with state and federal codes.
- **Floor** - Must support at least 280 lbs. and be a solid, level surface. DO NOT install on carpet.
- **RV/Marine Installations** - When locating the appliance in a towable trailer or watercraft, position the machine over the axles or mid-ship where movement is at a minimum. Block the machine to prevent extreme movement.
- **Exhaust Requirements** - Rigid or flexible metallic duct required. Ducting should be as short and straight as possible. DO NOT exhaust dryer into a chimney, furnace, cold air duct, attic crawl space, or another duct used for venting. If a cabinet door is installed, a minimum of 8 sq. in. should be provided for make up air. Louvered doors with equivalent air openings are acceptable. Allow clearances behind door(s) to avoid rubbing between back of cabinet door(s) and front of unit control panel. Additional clearances for wall, door and floor moldings may be required.

If you have...	You'll need...
no access to Hot/Cold water hookups	Splendide Faucet Adapter Kit, or equivalent.
to install a dryer vent and ducting in your RV or boat	Splendide Vent Kit, or equivalent.
concerns about the appliance shifting in your RV or boat	Splendide SecureFit bracket kit, or equivalent.
water damage concerns	Splendide Drain-A-Way Pan, or equivalent.
to make a 90° duct turn in less than 4.5"	Splendide 90° offset elbow, or equivalent.

Drainage

Standpipe Diameter/Capacity - Needs a 1 ¼" minimum diameter standpipe with a minimum carry-away capacity of 7 gallons per minute.

Top of Standpipe - Must be between 25" and 34" high from the bottom of the machine.

Outlet End of Drain Hose (provided with the unit)

- Must be at least 20" above the bottom of the washer-dryer. An air break must be available at the standpipe to avoid siphoning. No more than 6" of the drain hose should be inserted into the drain pipe to prevent siphoning.

Installing the washer-dryer

Unpacking the washer-dryer

- Carefully remove the packing materials with care not to damage the drain hose and power cord that are shipped installed on the machine. Check that the machine is intact. Report any damage immediately.
- Position the washer-dryer near the desired installation position.



WARNING! Plastic bags, styrofoam, nails and other packaging parts are not children's toys and can be potentially dangerous. Destroy the carton and plastic bags after the washer-dryer has been unpacked.



IMPORTANT: Retain the transit screws, spacers and rubber tubes. These items should be reinstalled to prevent damage if or when you transport the machine in the future.

Connecting the water inlets

If the water pipes you will be connecting to are new or unused, run the water until clear to remove any debris that could clog the water valve screens or valves before connecting the machine. NOTE: Supply shut-off valves should be easily accessible.



IMPORTANT: Water pressure MUST range within the values indicated on the "Technical Data" chart

Removing the transit screws

For transportation, the inside of the machine is supported by screws, rubber grommets and spacers on the back panel. Before using the washer-dryer, these items MUST be removed.



IMPORTANT: Transit screws and spacers must be removed before operating the machine to allow proper operation of the machine and to prevent damage to the appliance.

- After positioning the washer-dryer near the installation location, remove the four screws (Fig.1), with the rubber grommets and plastic spacers that are attached to them.
- Use the plastic plugs (provided in the accessories bag) to fill in the holes.

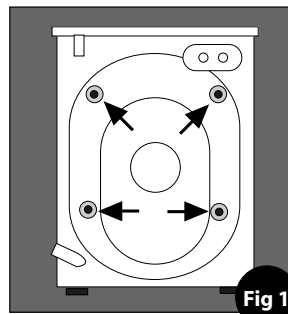

- Included in the accessories supplied with your machine are 2 inlet hoses with 4 rubber washers pre installed. Check that the rubber washers are installed in the ends of the inlet hoses to make a water tight seal at each connection point.
- Connect the straight ends of the water inlet hoses to the supply taps that have $\frac{3}{4}$ " BSP thread (standard hose bib).
- Connect the 90° angled ends (20 mm thread) of these hoses to the inlet valves on the back of the machine (Fig. 2). NOTE: Water Inlet valves are color coded: Red (Hot) & White (Cold).

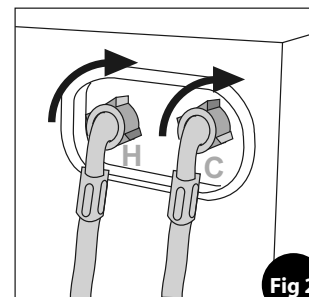

IMPORTANT: Do not use excessive force. Damage to the couplings can result. The couplings should be tightened by hand; a tool should only be used if a leak occurs.

Connecting the drain hose

It is possible for the water to be discharged into a sink, standpipe or drainpipe, but an air break must be available at a minimum 20" height to prevent the machine from siphoning (Fig. 6).

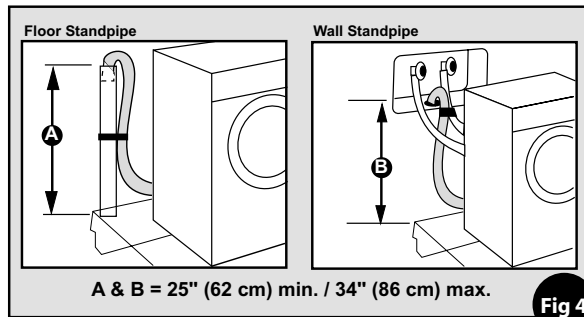

Standpipe Drain System - Installations require a minimum 1 ¼" (3.2 cm) diameter standpipe with a minimum carry away capacity of 7 gallons (26 liters) per minute.

Wall or Floor Standpipe Drain System - The top of the standpipe must be between 25" (62 cm) - 34" (86 cm) from the bottom of the washer (Fig. 4).

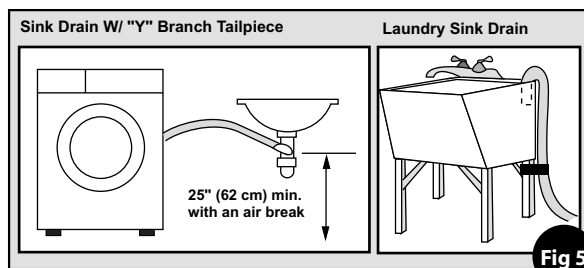

Sink Drainpipe System - Entry into the sink drain system must be above the trap (Fig. 5). When routing the drain hose through cabinets or walls, use a protective material such as electrical or duct tape to cover sharp edges that could damage the drain hose. Use a suitable clamp to secure the drain hose to the "Y" branch or the disposer (Fig. 7). With a sink drainpipe system, you may connect directly: 1) to a disposer by following the manufacturers attachment



IMPORTANT: Make sure that the drain hose is not kinked and that water flow is not restricted.

method. 2) directly to a "Y" branch tail piece (available at most hardware stores). 3) Through the floor to a separate trap. The trap must be vented to prevent siphoning. To provide proper venting, install an Air Gap Kit (available at most hardware stores). 4) To the faucet using a Faucet Adapter Kit (available separately).

- Use a U-Clamp (provided in your accessories packet) or suitable item to secure the outlet end of the drain hose (pre-installed on the back of your machine).
- Insert the outlet end of the drain hose into the standpipe, wall or floor drain (Fig. 6). NOTE: The outlet end of the drain hose MUST be at least 20" (50 cm) above the base of the machine. No more than 6" of the drain hose should be inserted into the drain pipe to prevent siphoning.
- Use a strap, cable tie, or similar item to hold the hose or the U-Clamp in place.

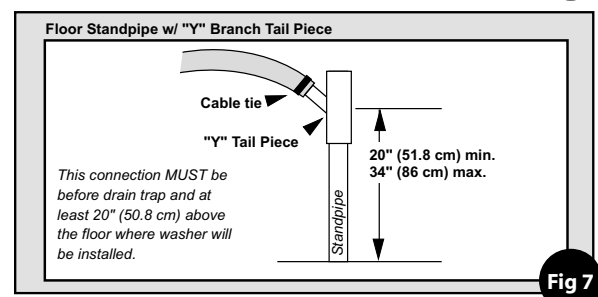
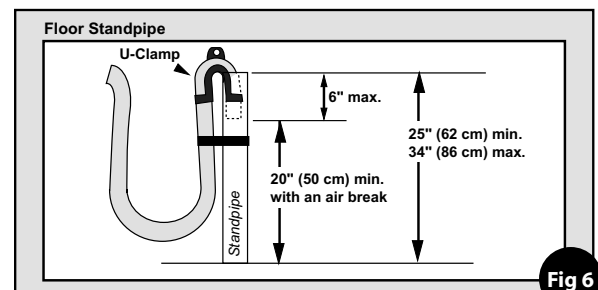

Installing exhaust ducting



IMPORTANT: This appliance should **NOT** be exhausted into a chimney, wall, ceiling, or any concealed space of a building. Only rigid or flexible metallic ducting should be used.

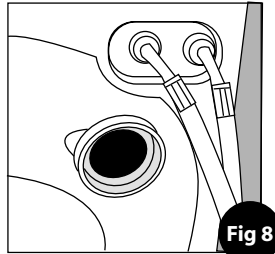

- Rigid or flex metal/metallic ducting should be used.
- Exhaust ducts should be as short and straight as possible. *NOTE: Long exhaust ducting can extend drying time, collect lint and may affect drying performance.*
- The exhaust duct must end with an approved exhaust vent hood with swing out damper(s) or tailpiece with louvers.
- Check that all ducting is clean and lint free. Use duct tape or screw clamps to secure all joints.
- Use duct tape or screw clamps to secure the duct to the round flange vent located on the back of the machine (Fig. 8).



WARNING! To reduce the risk of fire, this appliance must be exhausted to the outdoors.



Rigid or flexible metallic duct required. Ducting must be as short and straight as possible.



Do not exhaust dryer into a chimney, furnace, cold air duct, attic crawl space, or another duct used for venting.



If a cabinet door is installed, a min. opening of 8 sq. in. should be provided for make up air. Louvered doors with equivalent air openings are acceptable. Allow clearances behind door(s) to avoid rubbing between back of cabinet door(s) and front control panel. Additional clearances for all, door and floor molding may be required.

Leveling the washer-dryer

- To access the front leveling legs, tilt the machine backwards, leaning it against a wall or other stable structure.
- Adjust the legs up or down (Fig. 9) to ensure the washer is resting solid and does not rock side-to-side or front-to-back when the machine is upright.
- Check that the angle of inclination, measured according to the work top, does not exceed 2°.

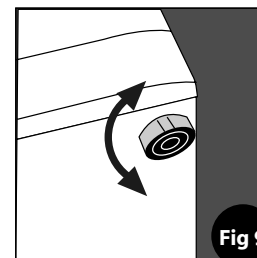

IMPORTANT: The machine must rest solid on a sturdy floor for optimum performance and minimum vibration.

Completing the installation

- Check the electrical requirements. Be sure that you have the correct electrical supply and the recommended grounding method.
- Check that the shipping brackets have been removed.
- Check that the water faucets are ON.
- Check for leaks around faucets and inlet hoses.
- Plug washer into a grounded 3-prong outlet.
- Slide the washer-dryer to its final location and confirm that it's level.
- When installing this appliance in an RV or marine vessel, you should block in the unit to prevent it from shifting or tipping. A SecureFit Bracket Kit is available from Splendide to keep the unit from shifting front-to-back or side-to-side.
- Test and clean the washer. Run a test load with no laundry.

Testing and cleaning the washer,

- Press the ON-OFF button to turn the washer ON
- Pour 1 to 2 TBSP of powder detergent into the detergent dispenser compartment '2'
- Select wash program '2'.
- Make sure the DRY TIME knob is in the 'OFF' position.
- Then press START. Allow the washer to complete the wash cycle.

About your washer-dryer



CAUTION
RISK OF ELECTRIC SHOCK
DO NOT OPEN



CAUTION: To reduce the risk of electric shock, DO NOT remove cover (or back). No user serviceable parts inside. Refer servicing to qualified service personnel.



The lightning flash with arrowhead symbol, with-in an equilateral triangle, is intended to alert the user to the presence of uninsulated "dangerous voltage" within the product's enclosure that may be of sufficient magnitude to constitute a risk of electric shock to persons.



The exclamation point within an equilateral triangle is intended to alert the user to the presence of important operating and maintenance (servicing) instructions in the literature accompanying the appliance.

Your New Appliance

Your new appliance is an automatic washer and vented tumble dryer by Splendide. Front-loading with a stainless steel drum and an extra large door opening for easy loading and unloading. It features 10 wash programs, 7 water temp. settings, 3 dry programs, and a 1200 RPM max. spin speed.

Automatic Dispenser Drawer

Automatically dispenses laundry aids (detergent, bleach, softener) during the cycle.

Auto Water/Energy Control

Automatically adjusts the amount of water and energy to use for each load.

Safety Door Lock

Protects you from opening the door when it is unsafe.

Express Wash

Washes lightly soiled Cotton Heavy Duty and Permanent Press fabrics in less time.

More Rinse Cycles

Most washers have only 1 rinse following each wash while your Splendide washer-dryer has up to 4. It rinses 2-3 times

after every wash (except Express Wash) and features an Extra Rinse button that adds yet another rinse to remove even more dirt/detergent from fabrics (recommended for those with detergent contact allergies).

Foam Removal System

Your machine automatically measures the amount of foam in circulation and adds water to the drum to remove excess foam for the highest rinsing performance.

Recirculating Wash Feature

With your Splendide washer-dryer, no detergent is wasted. Water recirculates and redistributes detergent throughout the drum in a way that assures all detergent is dissolved for max. resource efficiency.

Automatic Balance System

Every Splendide washer-dryer incorporates the latest motor technology. When it detects an out-of-balance load the motor will adjust speed (or come to a complete stop) and reposition the load automatically.

Impulse Spin Technology

Your machine features Splendide's exclusive IST processor that varies pulse in low spin for less wrinkling, less wear on clothing, less noise, less vibration, and improved energy efficiency.

Extra-Large Door Opening

For easier loading and unloading.

1200 RPM High Spin

For better drying performance.

Extra-Durable

Heavy duty springs, shock absorbers. Stainless steel drum.

Dryer Cool Down

The last few minutes of the dry cycle, your dryer will carry out a cool down period. Clothing will tumble freely without heat. This will cool fabric, buttons and snaps for safe handling and to reduce wrinkling.

Low Maintenance

Lint passes safely through a 'self-cleaning pump' and then out the drain or dryer vent - so there's no messy wash or dry filter for you to clean.

Description of the control panel

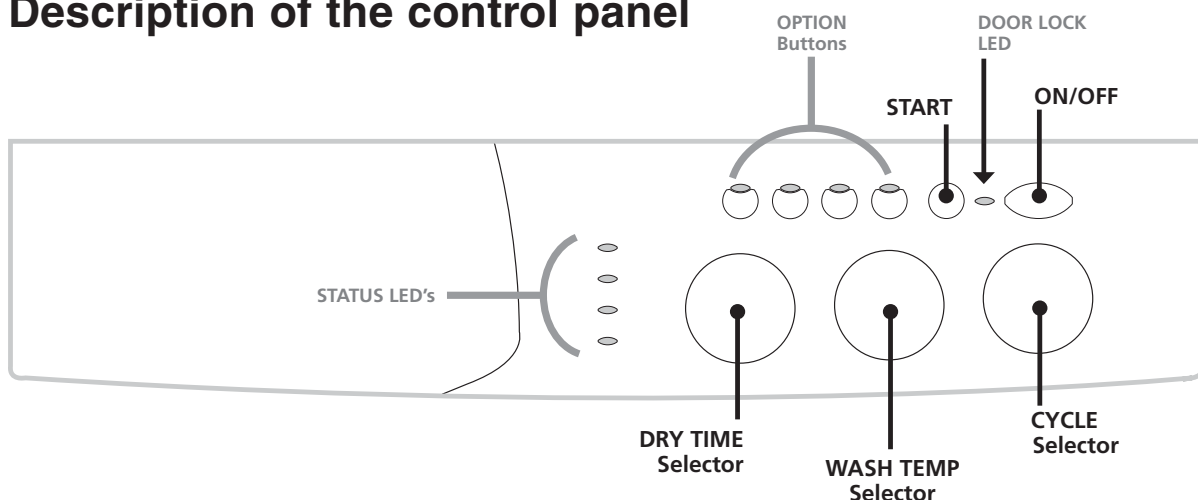

ON/OFF (Door Open) Button

Turns power to the washer ON or OFF, unlocks the door during the wash and dry cycles. Also restarts a SILK or WOOL cycle that's gone into Anticrease/ Soak.

DOOR LOCK LED

Indicates when the door is locked and when it can be safely opened:

SOLID=Locked, FLASHING=Unlocked

Once locked, the door can be unlocked for up to 5 MINUTES into any WASH cycle and at ANY TIME during a DRY cycle.

To unlock the door: Press the ON/OFF button.

To resume the cycle: Close the door and press the ON/OFF button again.



IMPORTANT: The rapid flashing of the DOOR LOCK LED together with flashing of at least one other LED indicates an abnormality (see Troubleshooting)

START (Cancel) Button

Press once to START the program, or press and hold to CANCEL a program in progress.

OPTION Buttons

Use these buttons to modify the wash cycle (see "Description of Option Buttons, page 12") .

STATUS LED'S

Indicates the cycle phase that's underway.

DRY TIME Selector

Use this knob to select the desired drying minutes. MAX LOAD will dry for 180 minutes and is recommended for full, 11 pound loads. *NOTE: This knob does not move during the dry cycle.*

WASH TEMP Selector

Use this knob to select the water temperature (when a WASH cycle is selected. *NOTE: Rinse water is always COLD.*

CYCLE Selector

Use this knob to select a WASH or DRY cycle. *NOTE: This knob does not move during the wash or dry cycle.*

Description of the Option Buttons

You can customize the wash by adding an OPTION or combination of options to your cycle selection. The button corresponding to the OPTION selected will remain LIT. *NOTE: If you push an OPTION button and it flashes, that means the OPTION you selected is not available for that cycle.*

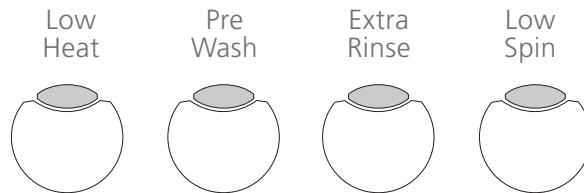

EXTRA RINSE - Adds an extra rinse to the wash cycle (Not available in Delicates)

LOW SPIN - Reduces the high spin speed to 600 rpm (Not available in Delicates). *NOTE: This option is not available if a Dry cycle is set.*

LOW HEAT - Reduces the dryer heat temperature of the selected dry cycle

PRE-WASH - Adds an extra fill at the beginning of the wash cycle

Description of the Program Key

The front of the dispenser drawer contains a Program Key to help you select a Wash or Dry Cycle using the Cycle Selector Knob.

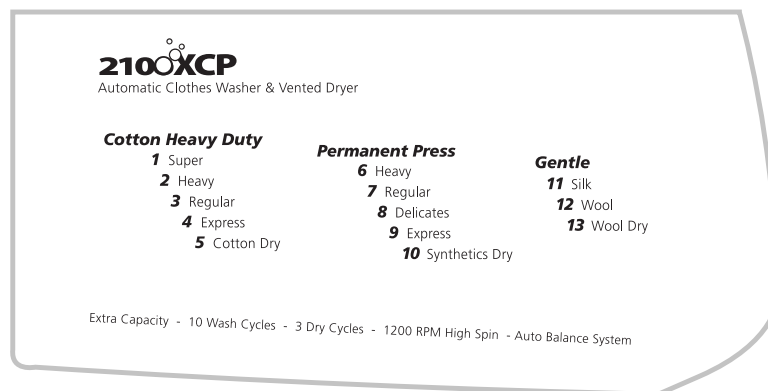

Optional

- All-Natural, HE detergent formulated for your washer-dryer
- Softens fabrics naturally

While not required, Splendide recommends the use of a High Efficiency (HE) detergent. HE detergents are quick dissolving and low sudsing and will deliver optimum results in your front-loading machine.



Splendide Premium Laundry Powder, Part No. 1005

Laundry Aid Type / Amounts

Your Splendide requires smaller amounts of laundry aids to get fabrics clean. Adding too much detergent won't necessarily make for a more efficient wash, and may in fact cause build up on your clothes and inside your appliance and even pollute the environment. Recommended laundry aid amounts per wash load:

- **Prewash detergent (Optional):**
1 to 2 TBSP Powder
(or 1 TBSP Liquid)
- **Detergent:**
1 to 2 TBSP Powder
(or 1 TBSP Liquid)
- **Fabric softener:**
1 to 2 TBSP (Liquid ONLY)
- **Bleach (Optional):**
DO NOT exceed the MAX fill line

About the Dispenser Drawer

Laundry products are diluted and dispensed automatically at the proper time during the wash cycle. The dispenser drawer has three compartments (plus one removable bin) for adding laundry products to the wash load. These compartments are:

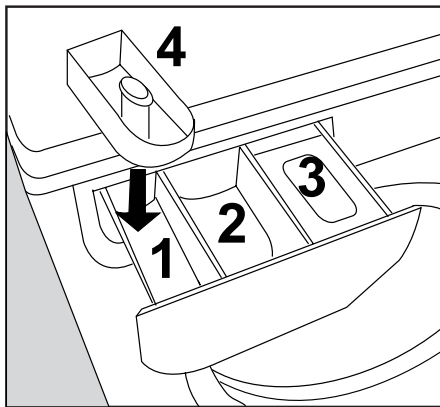

- 1 **PreWash Detergent** (With Bleach Bin removed)
- 2 **Detergent for the Wash Cycle** (Powder or Liquid)
- 3 **Fabric Softener** (Liquid)
- 4 **Bleach** (With Bleach Bin in place)



IMPORTANT: Adjust laundry aid amounts for heavily/lightly soiled loads, or hard/soft water. NEVER EXCEED the recommended amounts of detergent or fabric softener. Doing so could impair wash results and cause damage to the internal parts of your machine!



IMPORTANT: NEVER USE FABRIC SOFTENER SHEETS!



WARNING! Always dilute bleach before using. Never overfill bleach dispenser. Excess bleach could damage clothes.



IMPORTANT: The suds level should never rise more than half way up to the porthole. Too much foam will rise through the dispenser and make a mess on your floor



IMPORTANT: Using fabric softener causes items to release from the drum immediately after high-speed spin, helping clothes to dry faster while minimizing wrinkling and softening fabrics. NOTE: Splendide recommends using 1 to 2 tbsp. of a bio-friendly, or similar brand per wash load. These softeners tend to appear light in color and dissolve more quickly in less water, minimizing build-up within your machine.

Washing and drying

Cycle Description Chart

Fabric type	Degree of soil	Cycle Selector		Detergent		Fabric Softener	Bleach	Options Available	* Cycle Length	Cycle Description
		No.	Cycle Name	Pre Wash	Wash					
Cotton Heavy Duty Cycles										
Heavy cotton fabrics: i.e. sheets, socks, towels, jeans, underwear, sweatshirts, etc.	Exceptionally Soiled	1	Super		.	.	.	Low Heat Extra Rinse Low Spin	96 min.	Wash cycle, rinse cycles, intermediate and final spin cycles 1,200rpm high spin
	Heavily Soiled	2	Heavy	Low Heat Pre Wash Extra Rinse Low Spin	77 min.	
	Soiled	3	Regular	Low Heat Pre Wash Extra Rinse Low Spin	77 min.	
	Lightly Soiled	4	Express	Low Heat Pre Wash Extra Rinse Low Spin	63 min.	
	-	5	Cotton Dry	NOTE: A high spin is carried out during cycle 5 (Cotton Dry)				Low Heat	20 to 180 min.	Timed drying with spin cycle (High Heat)
Permanent Press Cycles										
Synthetic, light cotton and more delicate fabrics: i.e. button-ups, khakis, rayon shirts, etc.	Heavily Soiled	6	Heavy	Low Heat Pre Wash Extra Rinse	66 min.	Wash cycle, rinse cycles, intermediate and final spin cycles. 1,000rpm high spin
	Soiled	7	Regular	Low Heat Pre Wash Extra Rinse Low Spin	59 min.	
	Lightly Soiled	8	Delicates	Low Heat Pre Wash Extra Rinse Low Spin	53 min.	
	Lightly Soiled	9	Express	Low Heat Low Spin	33 min.	
	-	10	Synthetics Dry	When drying fabrics prone to wrinkling, choose cycle 10 (Synthetics Dry) with LOW HEAT pressed				Low Heat	20 to 180 min.	Timed drying (Medium Heat)
Gentle Cycle										
Silk and particularly delicate fabrics	Soiled	11	Silk**	Pre Wash Extra Rinse	30 min.	Wash cycle, rinse cycles, antcrease and Drain ONLY. NO SPIN CYCLE.
Wool fabrics	Soiled	12	Wool	Low Heat Extra Rinse Low Spin	65 min.	Wash cycle, rinse cycles, antcrease and spin cycles 800 rpm high spin
Wool fabrics ONLY	-	13	Wool Dry**	To prevent wrinkles, cycles 11 and 12 will end with the laundry left to soak and the 'Rinse' LED flashing. To finish the cycle, press the START button.				Low Heat	20 to 180 min.	Timed drying (High Heat)
About Rinse, Spin and Drain										
* Cycle lengths may vary according to water pressure, load size and fabric type		Rinse		NOTE: When using liquid fabric softener, it is dispensed automatically during the rinse cycle				Low Heat Extra Rinse	35 min.	Rinse cycles, intermediate and final spin cycles
		Spin		NOTE: High spin speed varies depending on the cycle you choose				Low Spin	16 min.	Draining and final spin cycle
		Drain		Drains any water from the drum				-	1 to 4 min.	Drain ONLY. NO SPIN CYCLE.
** Silk cycle cannot be set to go from 'wash-to-dry' automatically.										

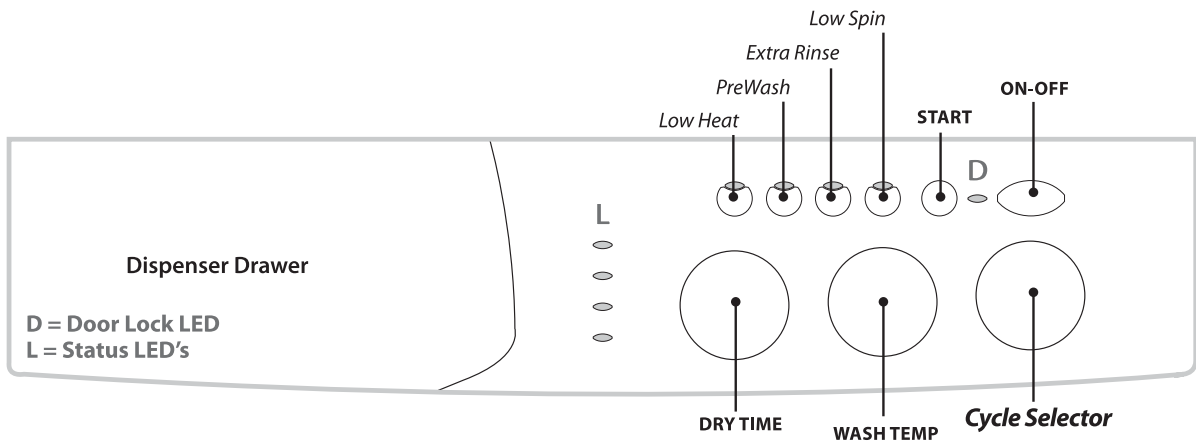

D = Door Lock LED
L = Status LED's

Before starting a cycle

Always make sure,

- the drum is loaded correctly (see below)
- the door is closed
- the ON-OFF button has been pressed and machine power is ON
- laundry aids have been added to the Dispenser Drawer (see below)



IMPORTANT: DO NOT attempt to open the door when the 'Door Lock' LED (D) is LIT SOLID!

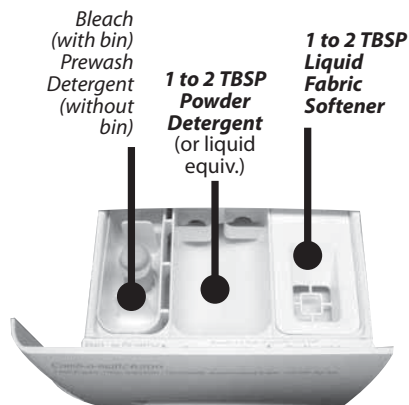

Determining load sizes

Maximum WASH CYCLE capacity - Cottons: 15 lbs, Synthetics: 9 lbs, Delicates: 8 lbs, Wools: 3 lbs

Maximum DRY CYCLE capacity - 8 to 11 lbs.

Always allow space for air to flow around the clothes when drying. In general, if your drying, don't fill the drum more than 1/2 to 3/4 full.

Setting a wash-to-dry cycle

1) Select the wash cycle

- select a washing cycle using the **Cycle Selector**;
- select the wash water temperature using the WASH TEMP knob;
- press available OPTION buttons (*optional*);

2) Select the dry time

- select the length of drying time with the DRY TIME knob; (*NOTE: Average loads will dry in 60 to 80 minutes*)

3) **Press the START button.** When the wash cycle ends, the appropriate dry cycle will start automatically

Setting a wash cycle

1) Select the wash cycle (See above);

2) Select the dry time

- set the DRY TIME knob to 'OFF';

3) **Press the START button.** When the wash cycle ends, the machine will stop.

Setting a dry cycle

1) Select the dry cycle

- set the **Cycle Selector** to position 5, 10, or 13;

2) Select the dry time

- select the length of drying time using the DRY TIME knob (20 to 180 min.);

3) **Press the START button.** When the dry cycle ends, the machine will stop.

Combine large and small items in one full

load. When washing single items such as a sweater, towel or jeans, add 1 or 2 similar items to help balance the load. Single, heavy items such as a bathrobe can be washed separately.

Do not wash rugs that could come apart and clog your machine.

For more delicate garments protect underwear, tights, stockings and other small or delicate items by placing them in a mesh laundry pouch while washing and drying.

When using the 'Wool' cycle, for best results, use a detergent that is for wool garments, taking care not to wash more than 2.2 lbs.

Splendide laundry tips

- Wash cycles are **30 to 96 minutes**.
- Dry times for average sized loads are **60 to 80 minutes**
- Wash cycles use 7 to 18 gal. of water. **YOU MAY NOT SEE WATER IN THE DRUM. This is normal.**
- **Once set, the DRY TIME, WATER TEMP and CYCLE SELECTOR knobs won't move.**
- The door automatically locks during the wash and dry cycles. **To unlock the door, access the drum, then RESUME the cycle, see DOOR LOCK LED on page 13.**

For best results,

- **DON'T OVERLOAD THE DRUM.** Keep up with laundry by doing smaller loads every day or two.
- **DON'T EXCEED RECOMMENDED DETERGENT OR FABRIC SOFTENER AMOUNTS.**
 - When going from 'was-to-dry' automatically, **Always use a fabric softener** (Or a Detergent with built-in softeners) so clothes release from the drum after the high speed spin.
- **ONLY use 'Cotton Heavy Duty' for heavy cottons** (towels, jeans, etc.)
- **For items that may wrinkle,** use 'Low Spin' in wash and 'Synthetics Dry'
- **To further prevent wrinkles,** set a 'wash ONLY' cycle with 'LOW SPIN' pressed. After the wash cycle ends, remove large items (pants, sheets, etc.) from the drum and shake them out. Loosely fold them and place them back in the drum. Then set a 'Synthetics Dry' cycle with 'LOW HEAT' pressed.
- **For mixed DRY CYCLE loads,** remove items that may wrinkle while still damp (dress shirts, etc.) Hand press and hang them. Then, continue drying the rest (underwear, towels, etc.)
- **NEVER OVER DRY LAUNDRY.** Over drying is a major cause of wrinkling. A certain amount of humidity is what makes fabrics soft and fluffy.



WARNING!

During the drying phase, the door tends to get quite hot.



Do not use the appliance to dry clothes that have been washed with flammable or chemical solvents (e.g. trichlorethylene).



This appliance can only be used to dry clothes that have been pre-washed in water.



Do not use the appliance to dry foam rubber or similar materials

Combo laundry FAQ's

Is using a combination washer-dryer much different than what I'm use to?

Yes, in some ways. You are washing and drying in the same drum and load sizes are smaller. Wash cycles are similar, but because combination washer-dryers are compact and operate using 115V (vs. 230V), dry times are longer. Instead of washing several, bulky loads of laundry in one day, you'll learn to adjust your laundry habits to launder smaller, more convenient loads every day or two.

Why do I need to load my drum less full for 'dry' and 'wash-to-dry' cycles?

Your machine can wash larger loads than it can dry. Remember, separate washers and dryers have drums of different sizes (the dryer drum is usually 2 times bigger), and your machine washes and dries in the same drum. When you program your machine to 'dry' or 'wash-to-dry' you must load the drum no more than 1/2 to 3/4 full. (NOTE: Automatic wash-to-dry not available when Silk is selected)

What factors affect drying times?

Drying times depend largely on the type of material (some fibers absorb more water than others), and the dampness of the articles when drying is started (1200 RPM spin vs. 800- 600 RPM spin), and on the amount of laundry that is being dried. Jeans, towels and similar (rather thick) articles will take longer to dry.

Sample wash-to-dry loads

To get you started, here are a few sample load sizes that can go directly from wash through dry. NOTE: Data purely indicative. Actual drying times will vary depending on type/weight of material.

Sample Load 1

- Wash Cycle: Regular Cotton Heavy Duty/ Dry Time: 65 min.
- 2-3 Bath Towels (27" x 52" / all 100% cotton)
- 1 Hand Towel (16" x 28")
- 1-2 Wash Cloth(s) (13" x 13")

Sample Load 2

- Wash Cycle: Regular Cotton Heavy Duty/ Dry Time: 55 min.
- 1 Flat Sheet (90" x 102" / all 230 thread count)
- 1 Fitted Sheet (60" x 80")
- 2 Standard Queen Pillowcases (21" x 32")

Sample Load 3

- Wash Cycle: Regular Cotton Heavy Duty / Dry Time: 60 min.
- 1 Hand Towel (16" x 28")
- 1 Pair Jeans (35" waist/32" inseam)
- 1 Sweatshirt (Large, 50% cotton, 50% polyester)

Care and maintenance

Turning off the water or electricity supply

Turn off the water supply after every wash. This will limit the wear of your appliance's water system and also prevent leaks. Unplug your appliance when cleaning it, while on vacation and during all maintenance operations.

Cleaning your appliance

The exterior and rubber parts of your appliance can be cleaned with a soft cloth soaked in lukewarm soapy water. Do not use solvents or abrasives.

Cleaning the dispenser drawer

Remove the dispenser by raising it and pulling it out. Wash it under running water; repeat as needed.

Caring for your appliance door and drum

When not in use, leave the appliance door ajar to prevent unpleasant odors from forming.

Checking the water inlet hoses

Check the water inlet hoses at least once a year. Clean the filters and the water valves. If you see any cracks, bulges or wear, replace hoses immediately; During the wash cycles, water pressure is very strong and a cracked hose could easily split open.



WARNING! Never use inlet hoses that have already been used.



IMPORTANT: Replace the inlet hoses at least every five years of use to reduce the risk of hose failure. When replacing the inlet hoses, mark the date of replacement on the label with a permanent marker.

Cleaning the pump pre-chamber

The washer-dryer is fitted with a self-cleaning pump that does not require regular maintenance. However, if small items (such as coins or buttons) fall into the pre-chamber that protects the pump, you will need to retrieve them.



IMPORTANT: Before cleaning, make sure the wash cycle has ended and unplug the appliance.



To access the pre-chamber:

- 1 Using a screwdriver, remove the cover panel on the lower front of the washer-dryer.



- 2 Place a small dish or tray below the cover. Unscrew the pre-chamber by rotating it counter clockwise. A little water may trickle out. This is perfectly normal.
- 3 Clean the interior thoroughly.
- 4 Screw the pre-chamber back on.
- 5 Reposition the panel, making sure the tabs are positioned correctly before you push the panel back onto the appliance.

No lint filter to clean

Your Splendide removes the lint automatically with the help of its self-cleaning pump, so there's no lint filter to clean. However, it is recommended that you occasionally inspect the outside vent and dryer ducting for any lint accumulation (see below).

Checking the dryer vent

Occasionally go outside and check the dryer vent for proper airflow. Assure that the vent and ducting are lint-free.

Troubleshooting

Before calling for assistance, make sure the problem can't easily be solved by consulting the following list

Problem	Possible Causes / Solution
<p>The washer-dryer won't start.</p>	<ul style="list-style-type: none"> • There is no power. • The appliance is not plugged into a socket, or not enough to make contact. • There has been a power failure. • The appliance door is not shut properly. • The START button has not been pressed. (Note: It should be held a minimum of one second.) • The water tap is not turned on or supply hoses are kinked.
<p>The washer-dryer does not fill with water.</p>	<ul style="list-style-type: none"> • The water inlet hose is not connected to the tap. • The hose is kinked. • The water tap is not turned ON. • The water pressure is insufficient. • The START button has not been pressed.
<p>The washer-dryer continuously fills and empties with water.</p>	<ul style="list-style-type: none"> • The drain hose is too low or too far into the standpipe. • The wall drainage system doesn't have an air break.
<p>The washer-dryer does not drain or spin.</p>	<ul style="list-style-type: none"> • Some programs have a slower final spin to take best care of the fabrics (See 'Cycle Description Chart', pg. 14). • The drain hose is kinked. • Check the pump pre-chamber (See 'Cleaning the pump pre-chamber,' pg. 18) • Remove the drain hose from the standpipe or under-sink trap and check for blockages, ensuring that the water can drain freely away from the machine.
<p>The washer-dryer vibrates too much during the spin cycle.</p>	<ul style="list-style-type: none"> • The Transit Screws are still in place. Remove the screws (See 'Removing the transit screws', pg. 6). • Verify the washer is resting on a solid, level surface. • The drum is overloaded. • The washer-dryer is not level (See 'Levelling the washer-dryer', pg. 8). • The washer-dryer is too close to cabinets or adjacent walls.
<p>The washer-dryer leaks.</p>	<ul style="list-style-type: none"> • The water inlet hose is not screwed on correctly (See 'Connecting the water inlets', pg. 6). • The washer is not level. • The drain pump or drain hose is obstructed. • The detergent dispenser is obstructed (See 'Cleaning the dispenser drawer', pg. 18). • The drain hose is not secured properly. (See 'Connecting the drain hose', pg. 7).
<p>FAULT CODES: The DOOR LOCK LED flashes rapidly at the same time as at least one other LED</p>	<p>The unit has entered diagnostic mode and there may be a problem.</p> <ol style="list-style-type: none"> 1. Unplug the unit, or turn off the circuit breaker to the unit for a minimum of 40 seconds. 2. Plug the unit back in, and switch the machine back ON. 3. If the unit still enters the diagnostic mode, please record which lights are flashing, as well as the model and serial number of your machine. 4. Call Splendide Technical Support.

Problem	Possible Causes / Solution
There is too much foam.	<ul style="list-style-type: none"> The detergent is not suitable for washing machines (it should be labeled "For washing machines" or "hand and machine wash," or the like). Too much detergent or softener being used.
The dryer does not start.	<ul style="list-style-type: none"> The appliance is not plugged into the socket, or not enough to make contact. There has been a power failure. The appliance door is not shut properly. The DRY TIME Knob is on the 'OFF' setting.
Poor drying performance	<ul style="list-style-type: none"> The drum is overloaded. The exhaust hose is obstructed.
Wrinkling	<ul style="list-style-type: none"> Incorrect sorting. The drum is overloaded. Incorrect wash cycle Clothes matted to the drum after spin. Refer to www.splendide.com for additional fabric care tips.

If you need assistance

Every Splendide washer-dryer comes with a Limited Warranty. Please read the Limited Warranty Statement that came with your machine for complete details. You'll find many answers to common problems in the "Troubleshooting" section of this manual. If you review this section first, you may not need to call for service at all.

NOTE: You will be charged for a service call while the appliance is under warranty if the problems are not caused by defective workmanship or materials.

- If you do need service, you can relax knowing that help is only a phone call away. Call our Splendide Technical Service/Assistance Department toll-free at 1-800-356-0766 Monday-Friday 7:00AM-5:00PM Pacific Time.
- Please have the model number and serial number of your washer-dryer ready when you call.



Splendide Technical Service
15650 SE 102nd Ave
Clackamas, Oregon 97015 - USA

1-800-356-0766
(Ext. 5)

Hours: Mon-Fri 7AM-5PM (PST)
Local Phone: 503-655-2563



Splendide Laundry Centers, A Division of Westland Sales
15650 SE 102nd Ave (PO Box 427)
Clackamas, OR 97015 - USA

Phone: 1-800-356-0766
Email: splendide@westlandsales.com
Fax: 503-656-8829
Web: www.splendide.com