

Align template to rear edge of recess



Align template to rear edge of recess



SK03 STACK KIT MOUNTING INSTRUCTIONS AND PATTERN

FOR USE WITH TVM63X OR DV6400X 110V ELECTRIC DRYER & ARWXF129W OR WFL1300XD FRONT-LOADING WASHER

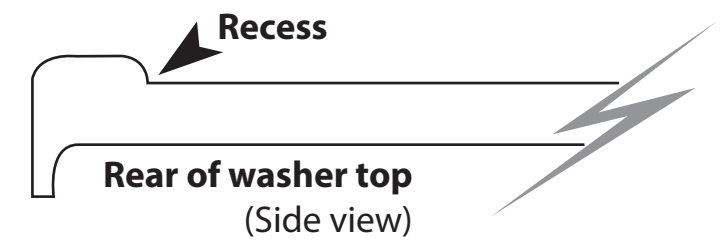
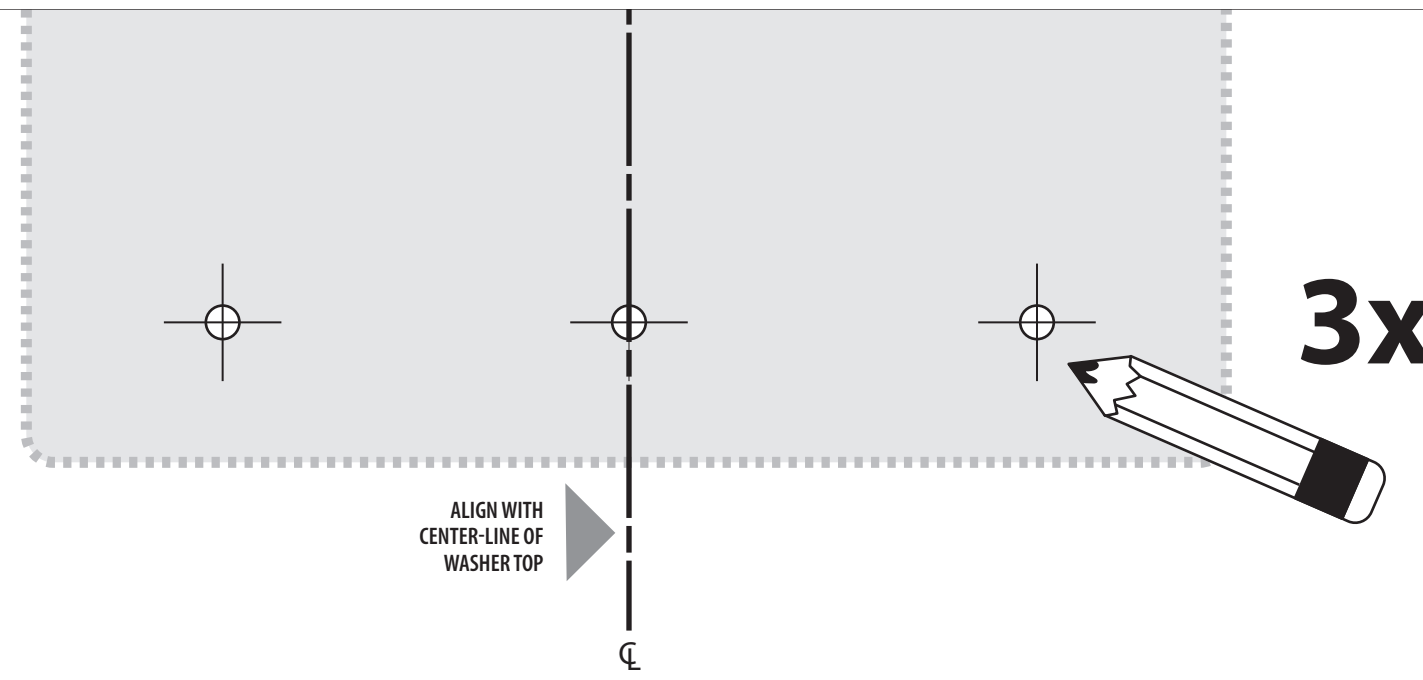

- 1x **C**
- 1x **E** **F**
- 1x **E** **G**
- 7x **D** **D**
SIZE 3/32"
DRILL BIT NOT INCLUDED
- 3x **F**

TVM63XNA or DV6400X Dryer

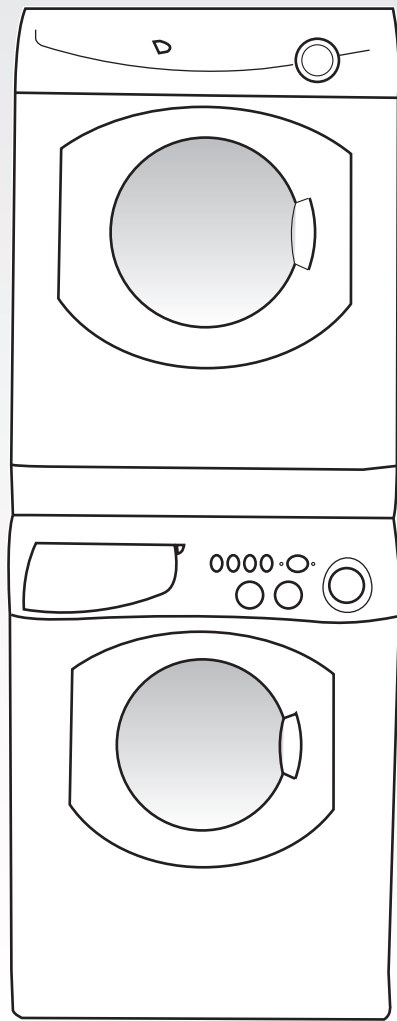

ARWXF129W or WFL1300XD Washer

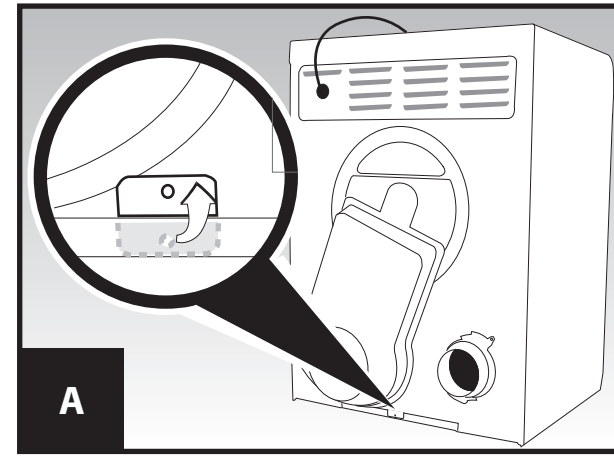

A Bend tab up so rear bracket can be inserted later

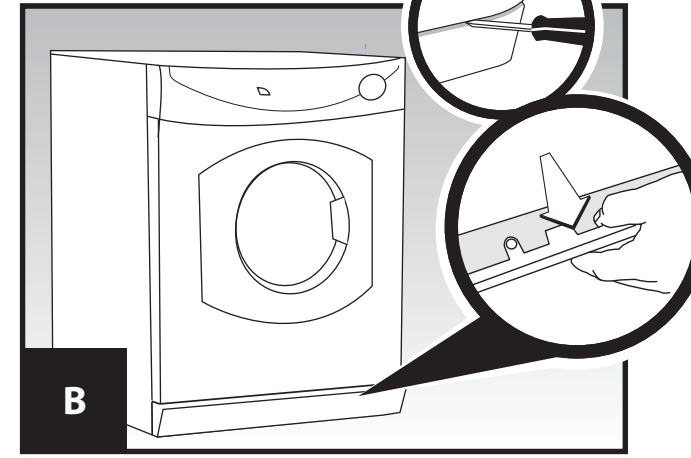

B Remove dryer kick-plate

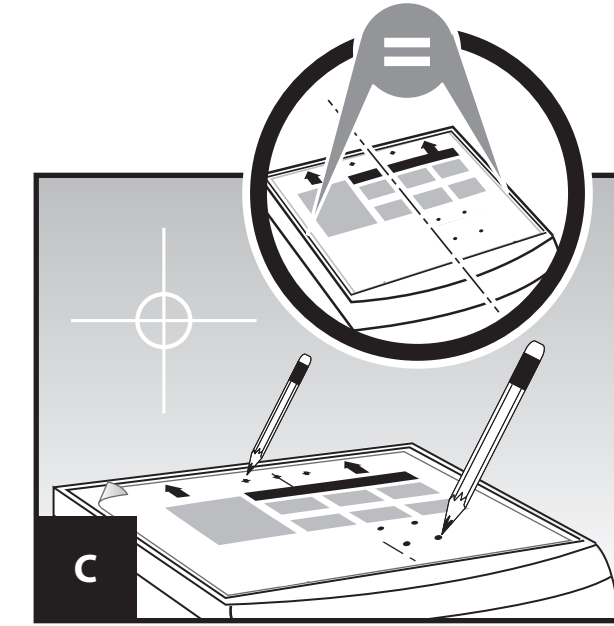

C Use pattern to mark drill hole positions on washer top

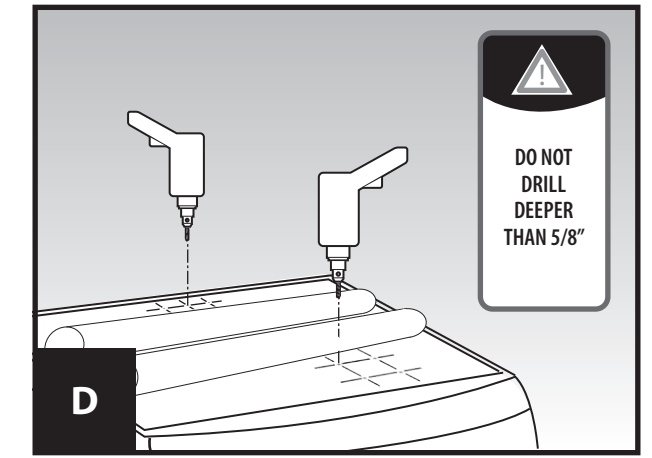

D Drill holes into washer top

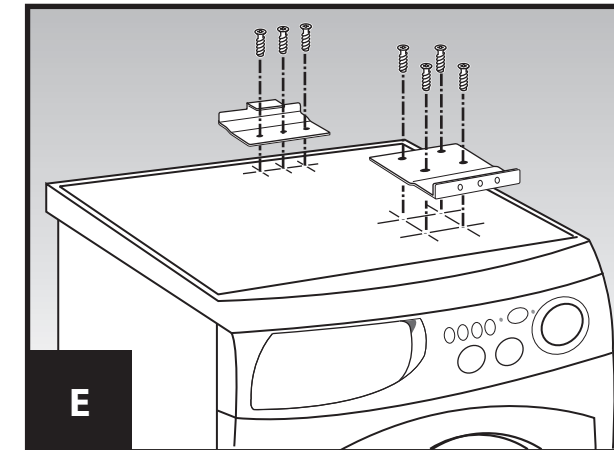

E Secure brackets to washer top

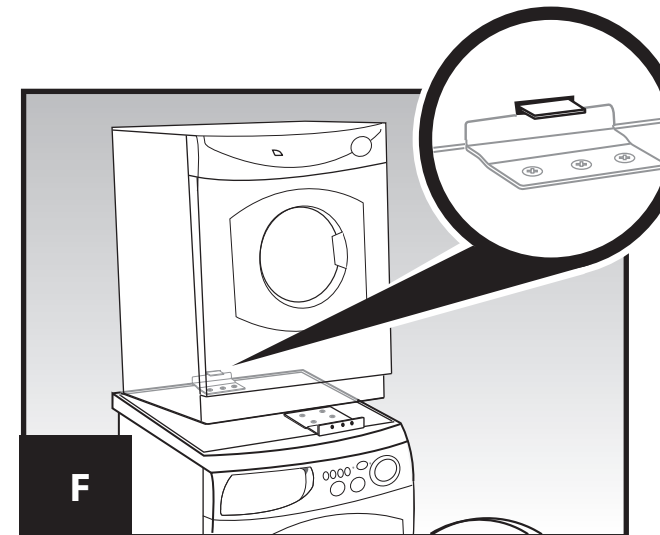

F Insert rear bracket into dryer

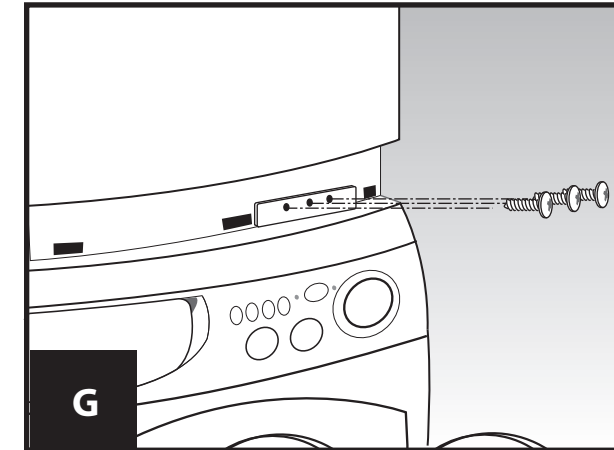

G Secure front bracket to dryer

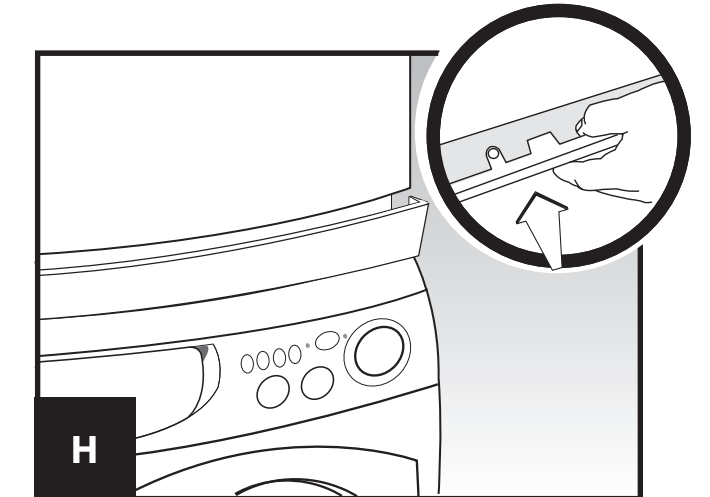

H Reinstall dryer kick-plate

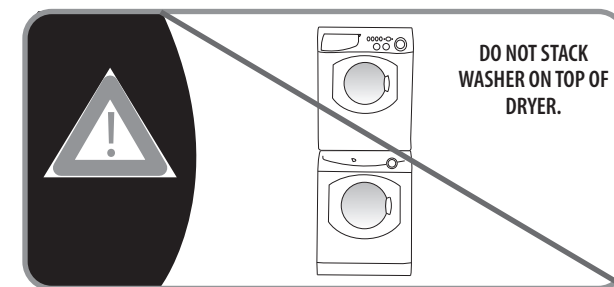
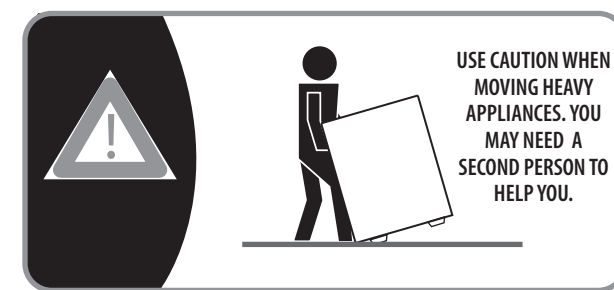

4x

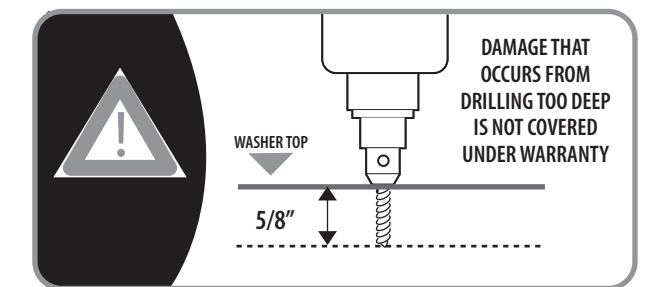
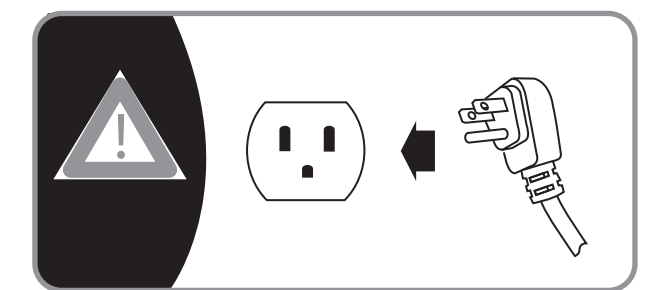
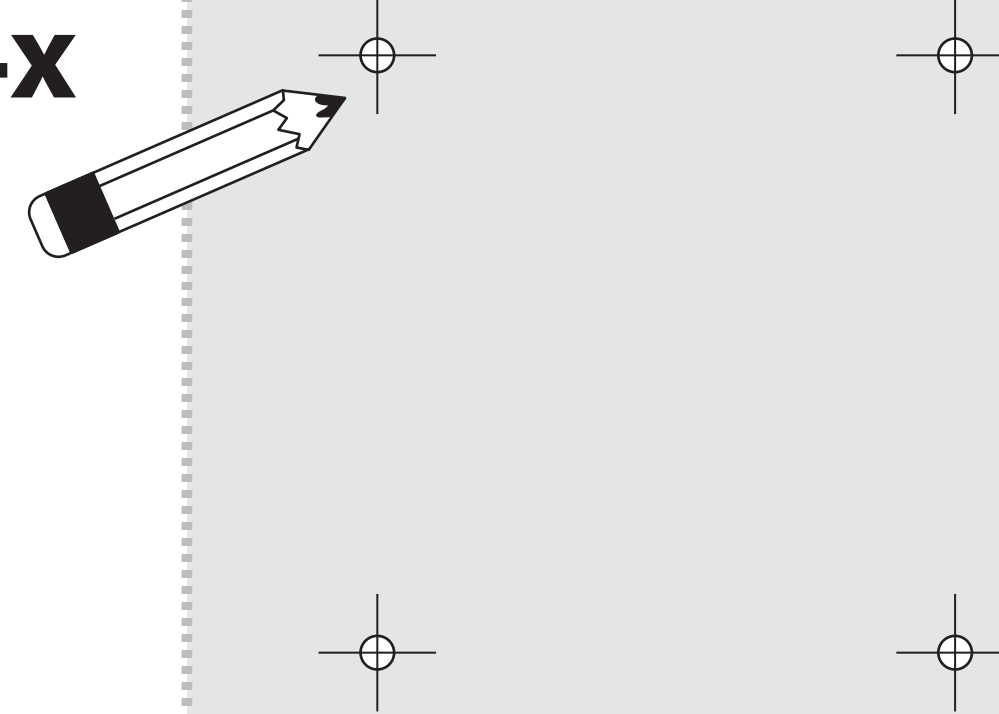

USE ONLY SCREWS FROM KIT